

Corner fixing kit CFK 100-150

Description: Fixing kit for shaping curves and T-joins.

This kit contains all necessary references to form curves and T-joins on EASYCONNECT Cable Basket Trays. The JS500EZ is fixed to the side of the Cable Tray using 5 pcs of FASEZ using 1 of them to fix the "Wire Base EZ" to the corner of the basket tray.

| Kit Components | FASEZ | JS500EZ | Wire Base |
|----------------|-------|---------|-----------|
| CFK100EZ | 5 | 1 | 1 |
| CFK150EZ | 10 | 2 | 1 |

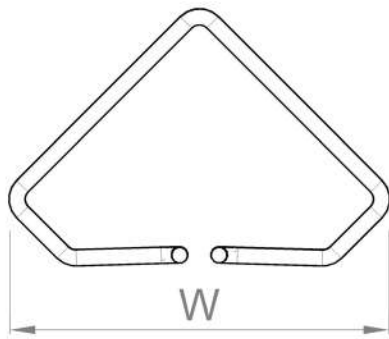
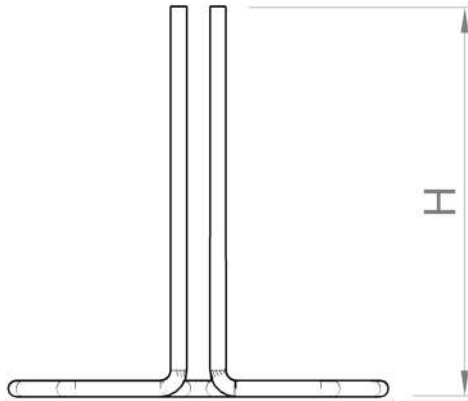

| Ref. Code | H (mm) | W (mm) | L (mm) | Weight (Kg/unit) |
|--------------------|--------|--------|--------|------------------|
| Wire Base CFK100EZ | 105 | 100 | --- | 0,042 |
| Wire Base CFK150EZ | 150 | 100 | --- | 0,051 |
| JS500EZ | 22 | --- | 500 | 0,125 |
| FASEZ | --- | 23 | 20 | 0,018 |

Suffix Code

Description of Coating / Material



Electrolytic Zinc Plating + Passivation with trivalent Cr.
Corrosion Resistance: Classified 2 according to IEC 61537.



Austenitic Stainless Steel AISI 304 or AISI 316L.
Corrosion Resistance: Classified 9D according to IEC 61537.

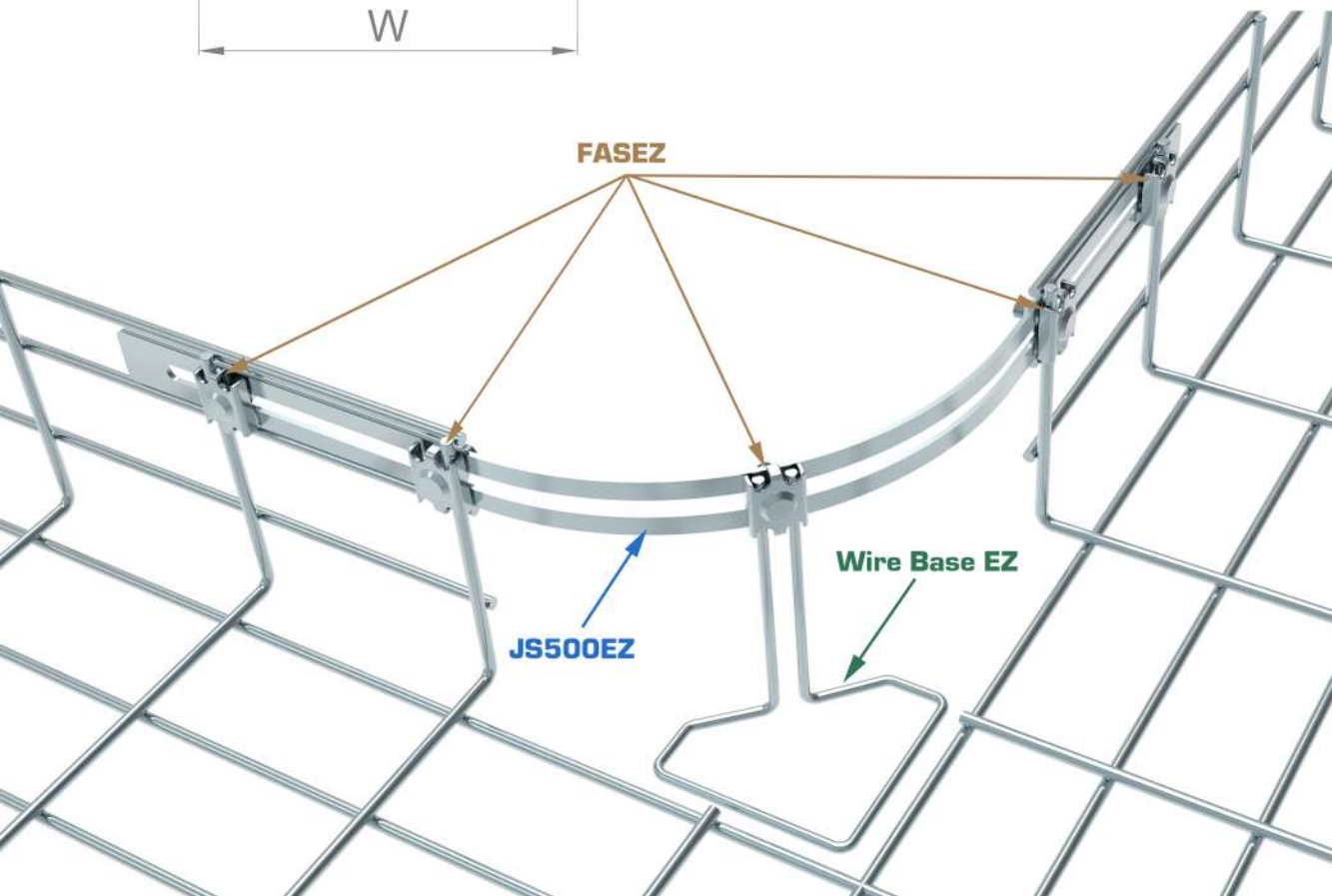

Annex. Installation Instructions for Shaping T-joints

EC100.600

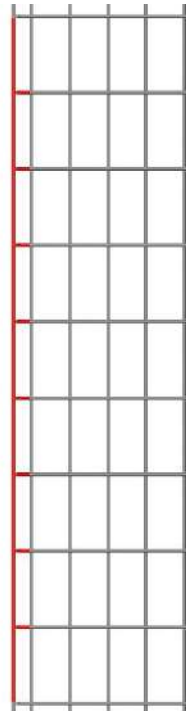
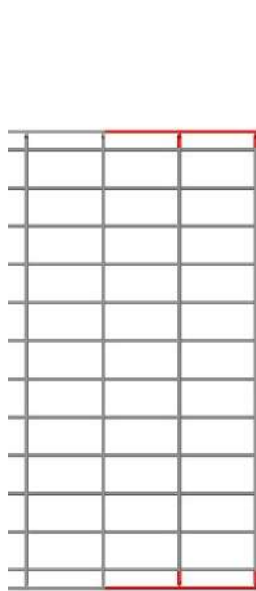

| Reference | N |
|-----------|---|
| EC100.200 | 5 |
| EC100.300 | 6 |
| EC100.400 | 7 |
| EC100.450 | 7 |
| EC100.500 | 8 |
| EC100.600 | 9 |

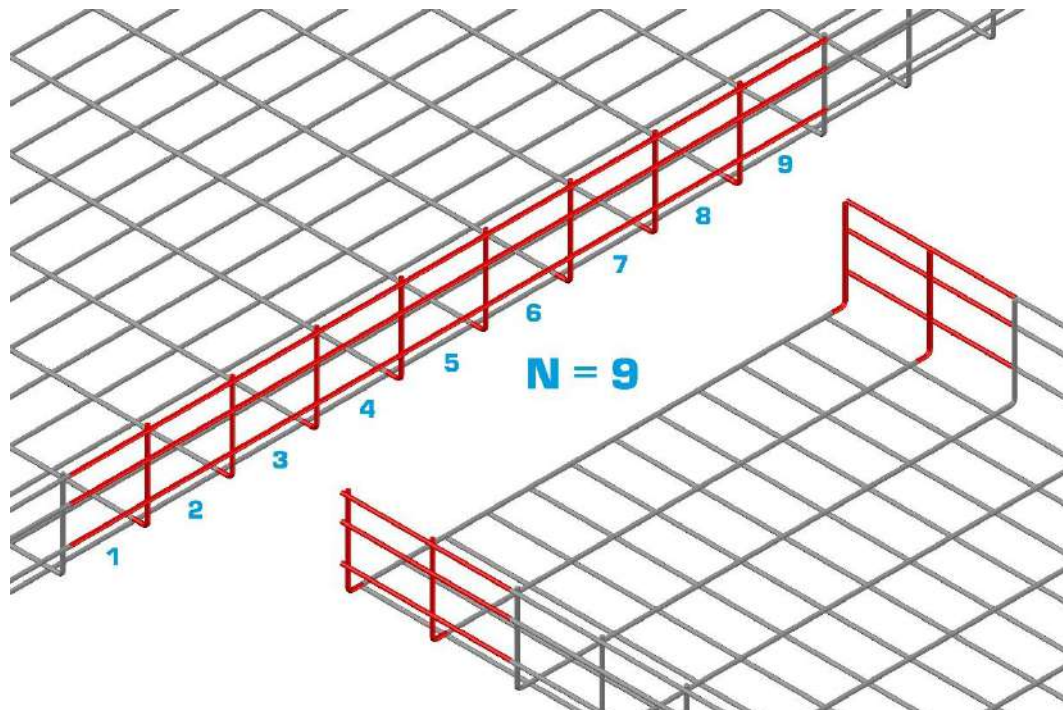

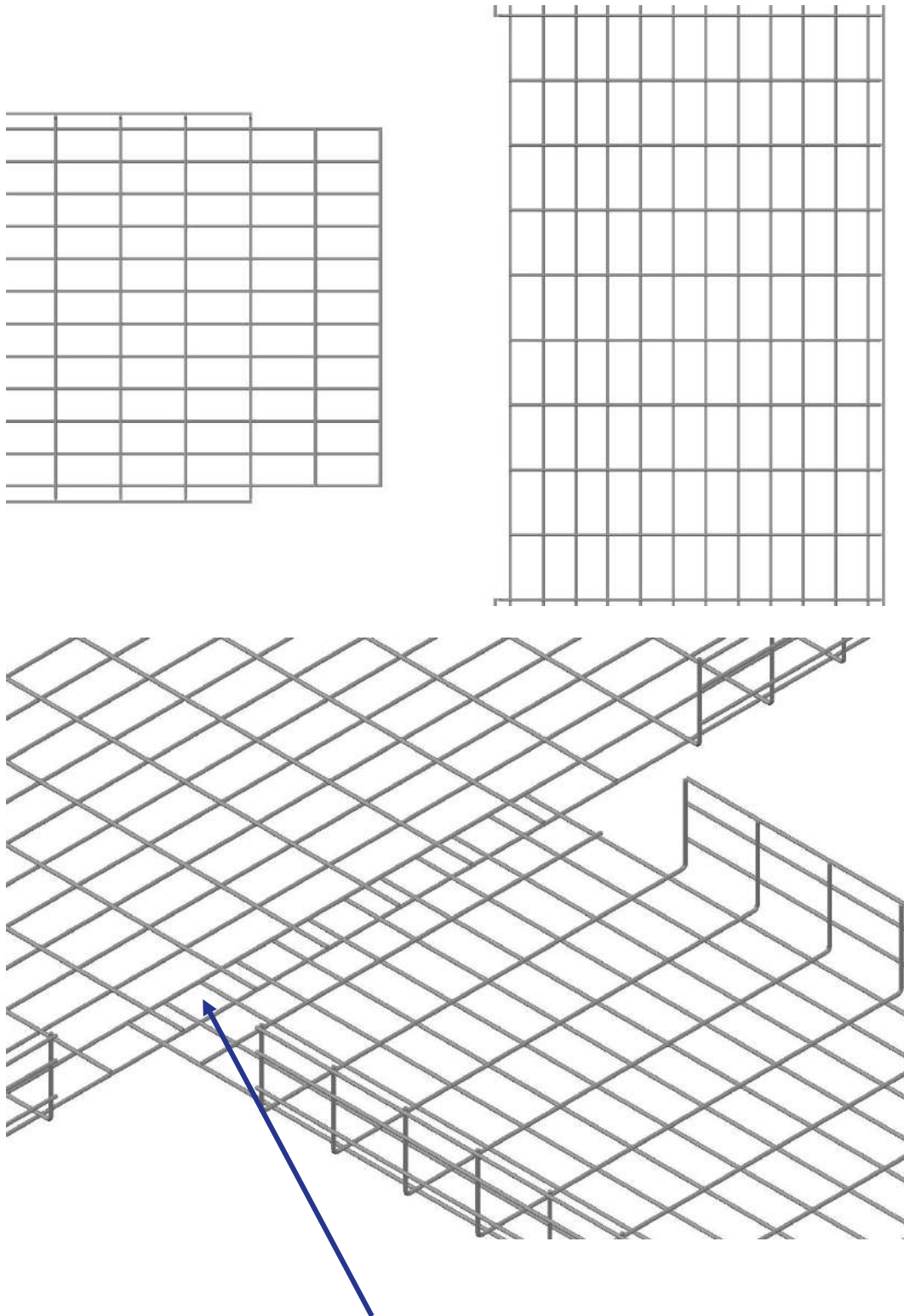

The basket sections are mounted overlapping 1 section as shown in the drawing

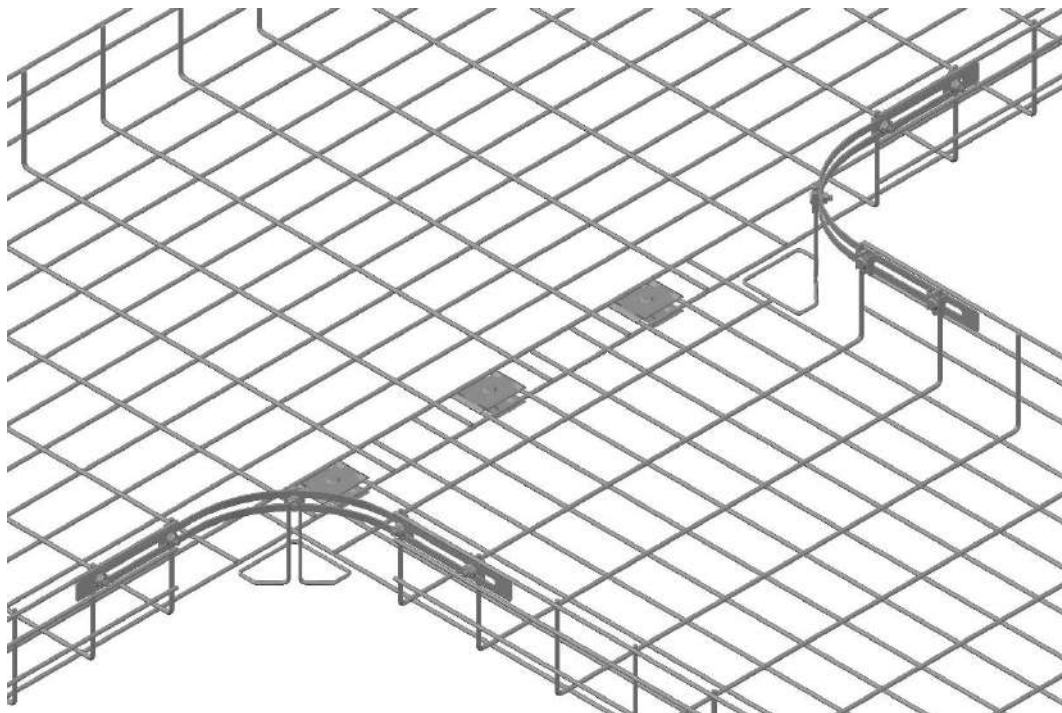
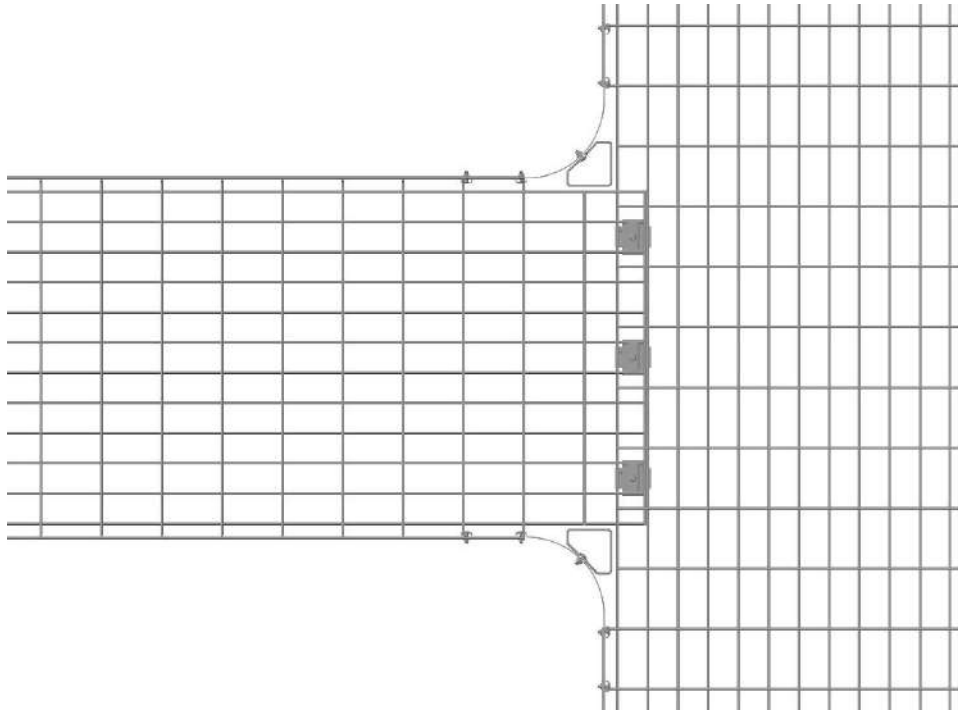

Valdinox SL, sociedad española inscrita en el Registro Mercantil de Cantabria al Tomo 514, Folio 13, Hoja 4353, NIF E5839336615 y domicilio en La Venera 14, Arnuero, Cantabria CP 39194

EC150.600

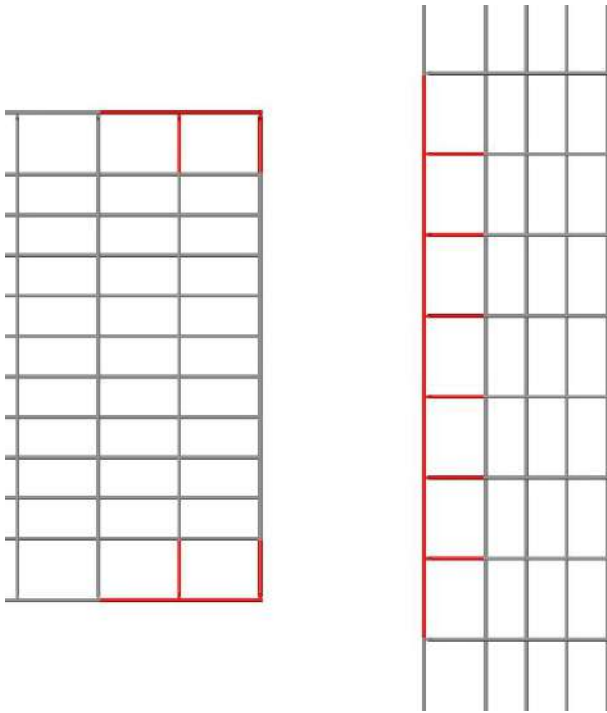

| Reference | N |
|-----------|---|
| EC150.200 | 5 |
| EC150.300 | 6 |
| EC150.400 | 7 |
| EC150.450 | 7 |
| EC150.500 | 8 |
| EC150.600 | 7 |

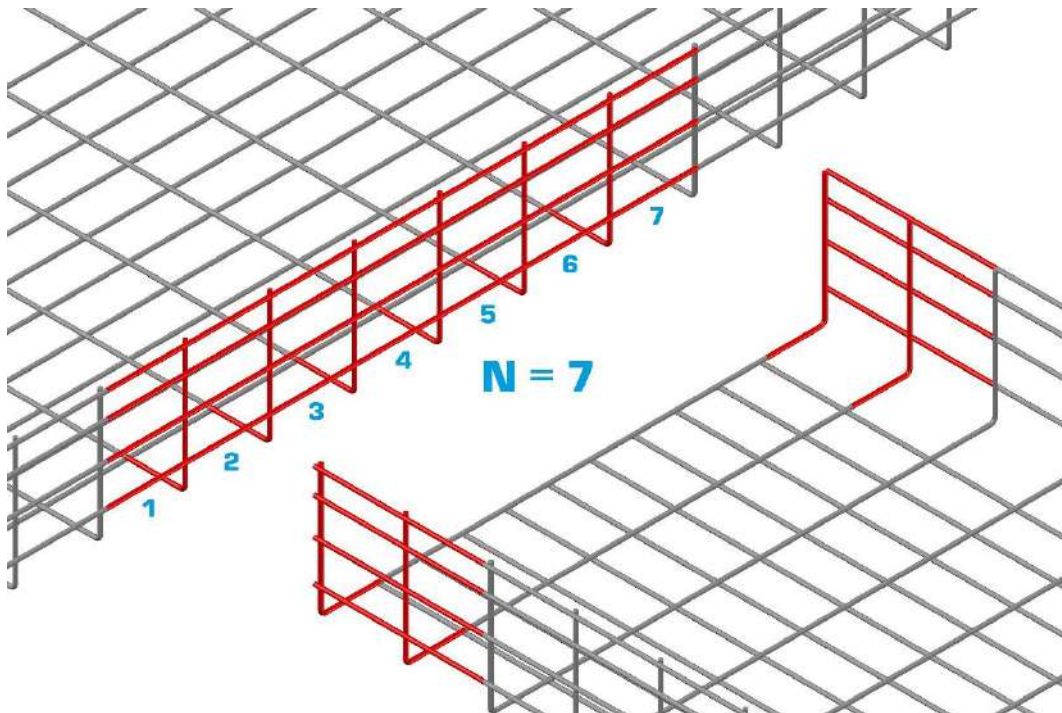

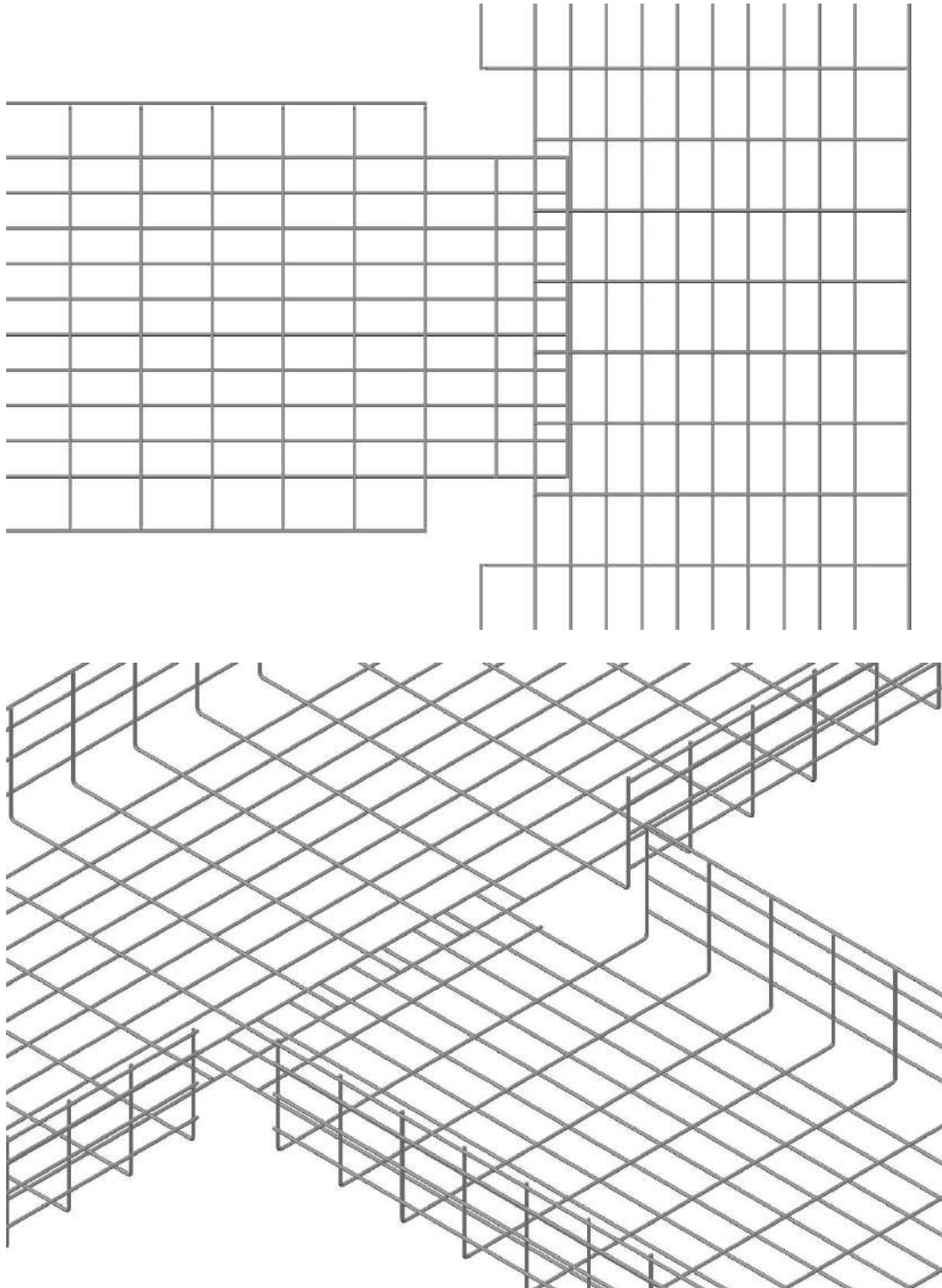

Valdinox SL, sociedad española inscrita en el Registro Mercantil de Cantabria al Tomo 514, Folio 13, Hoja 4353, NIF E5939336615 y domicilio en La Venera 14, Arnuero, Cantabria CP 39194



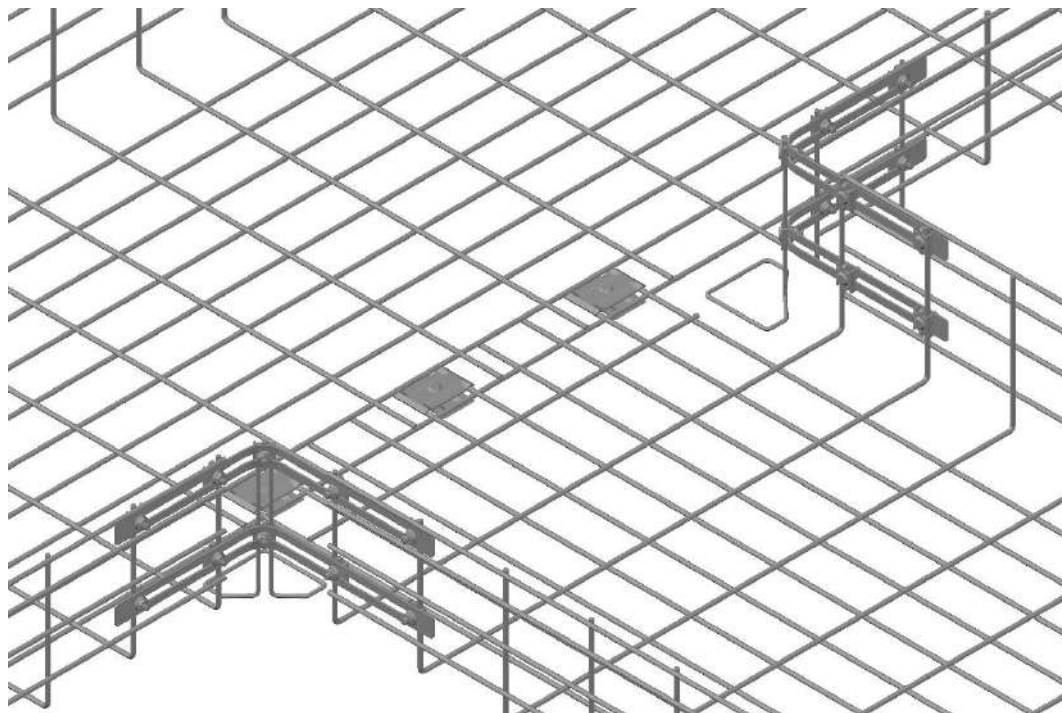
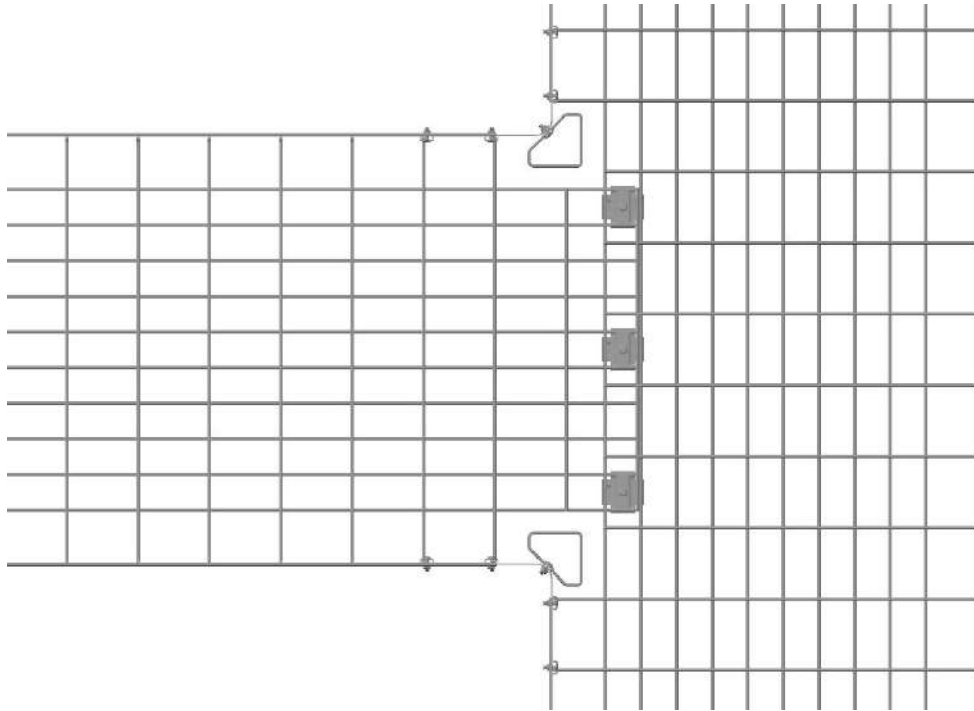

Valdinox SL, sociedad española inscrita en el Registro Mercantil de Cantabria al Tomo 514, Folio 13, Hoja 4353, NIF E5939336615 y domicilio en La Venera 14, Arnuero, Cantabria CP 39194

Fixing elements shown on the base (ref. SC6 + Screw Allen M6x25 + Nut M6) are recommended to fix the T-join.

The above mentioned elements are supplied separately.



| Reference | Number of fixing elements for the base |
|-----------|--|
| EC100.200 | 1 |
| EC100.300 | 2 |
| EC100.400 | 2 |
| EC100.450 | 3 |
| EC100.500 | 4* |
| EC100.600 | 3 |
| EC150.200 | 1 |
| EC150.300 | 2 |
| EC150.400 | 2 |
| EC150.450 | 3 |
| EC150.500 | 4* |
| EC150.600 | 3 |

* To obtain a symmetrical position of the fixing elements in the T base, a minimum of 2 or a maximum of 4 base fixings.

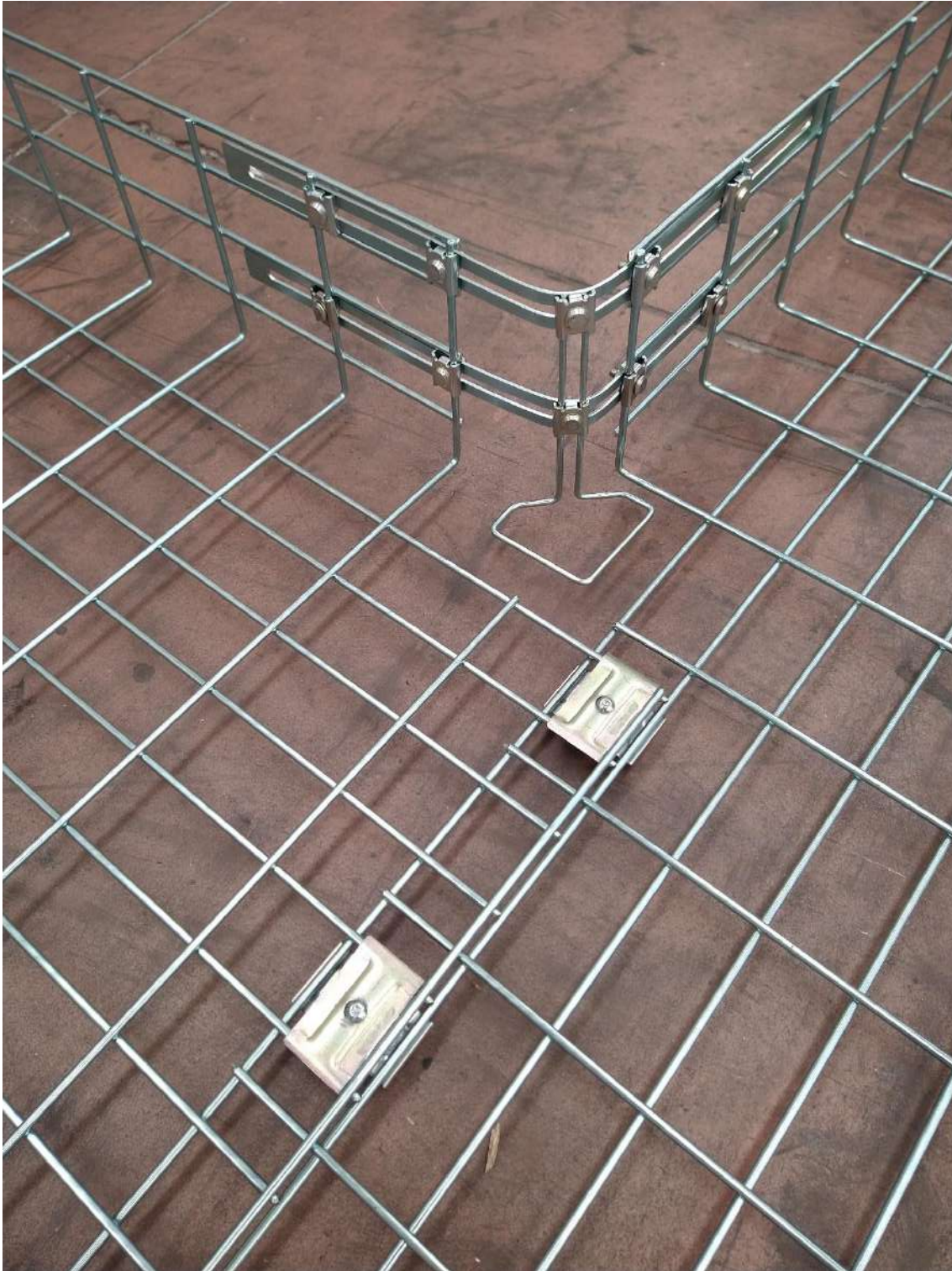

Figure 1: CFK150 on EC150.600



Figure 2: Fixing elements for the base